

*Manufacturer of customised packs and drapes.*



[www.nordset.de](http://www.nordset.de)

**NORDSET**  
GmbH & Co. KG

## OUR TEAM



Dear Customers,

the production plant was built in 2001 and since that time we have produced successfully sterile disposable packs and drapes for eye surgery. We produce the kits for our customers in Germany and all over Europe.

According to the requests of our customers, all drapes and packs are individually cut, punched and folded in our production facility in Northern Germany.

The manufacturing of the packs takes place in our high-standard clean room.

Disposable surgical drapes: Made in Germany.

We certainly have the CE mark and work according to those instructions. Enclosed please find a form for eye surgery packs that you can fill out and let us know the drapes and components required. We will be able to produce non-sterile samples within 5 days and sterile ones within 4 weeks upon receipt of these information in order to present the superior quality of our custom made kits.

Price quotations will be made immediately.

All our packs are ETO sterilized and can be used after 7 days' of quarantine.

Our highest goal is to satisfy our customers.

Kindest regards

**Kirsten Scholz & Team**



*Focus on Quality!*



## INTRAVITREAL PACKS

### Ref-Nr. 180515

1 table drape 150 x 100 cm as wrap  
1 surgical drape 50 x 60 cm, aperture 10 x 10 cm, incise film perforated  
and 1 fluid collection pouch integrated, **SMS**

3 absorbent sticks  
1 speculum AO-101M  
1 calipper M7500

1 label

### Ref-Nr. 060918

1 crepe paper 60 x 60 cm as wrap  
1 surgical drape 50 x 50 cm, **SMS**, aperture 6 x 8 cm - adhesive tape

#### 1 bag :

1 syringe 1ml L 9166017V  
2 absorbent sticks  
1 speculum closed **AO-100**  
1 calipper 3,5-4,0 mm

1 pair of gloves Gammex, size 6.5, powder free

1 label

### Ref-Nr. 060932

1 table drape 75 x 90 cm as wrap  
1 surgical drape 80 x 80 cm, aperture 7 x 10 cm, incise film integrated, perforated

#### 1 bag:

3 absorbent sticks in pouch  
1 eye pad closed  
1 calipper M7500  
1 speculum AO-101, closed

2 labels

## SURGICAL DRAPES

Euro Drape  
Surgical Drape  
134 x 108 cm  
aperture in middle of  
drape, incise film and  
fluid collection bag  
integrated

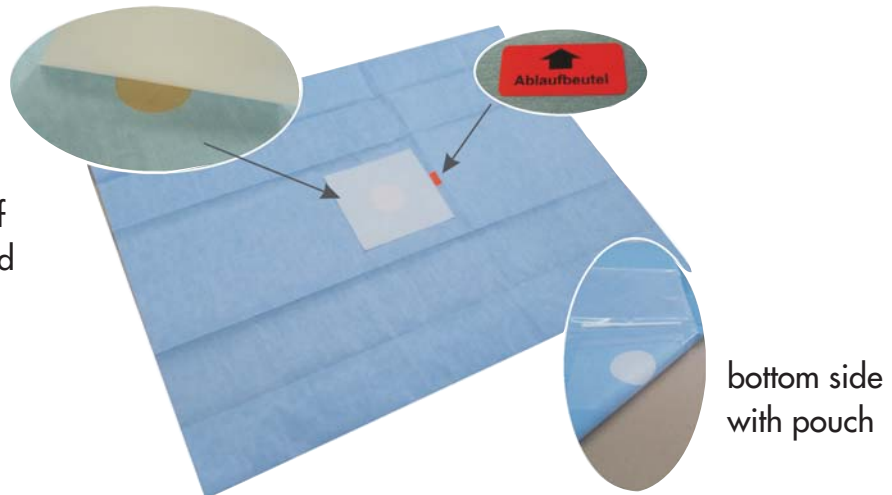

### APERTURES

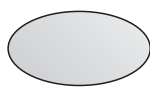

3 x 6 cm

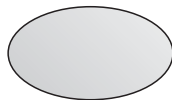

4 x 7 cm

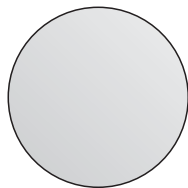

7,5 cm Ø

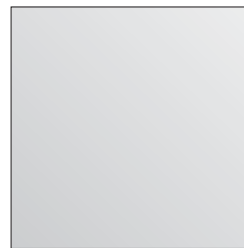

10 x 10 cm

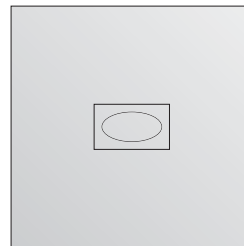

10 x 10 cm  
incise film  
integrated  
punched  
3 x 6 cm

## POUCHES SYSTEMS

### POUCH

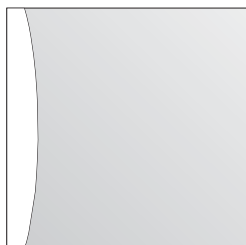

20 x 20 cm  
20 x 25 cm

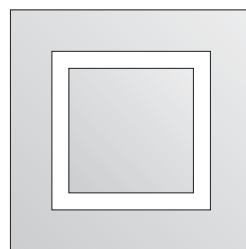

closed fluid collection  
system

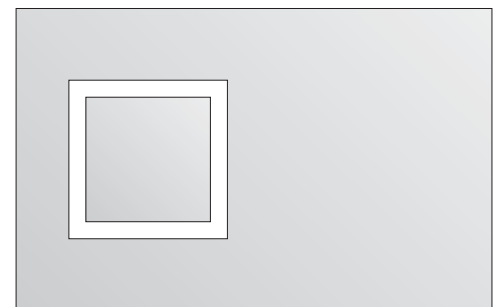

closed fluid collection system on side  
"channel" bag



## INCISE FILMS



15 x 20 cm



20 x 25 cm

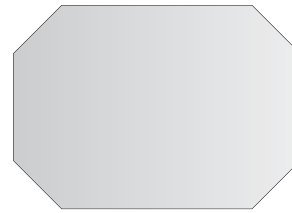

Tegaderm 10 x 12 cm



perforated incise film available

## COVERS

### INSTRUMENT TABLE DRAPE

Material:  
laminated non-woven

75 x 90 cm  
140 x 150 cm  
with / without tape  
with / without fixation

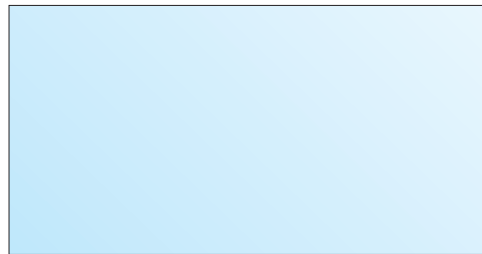
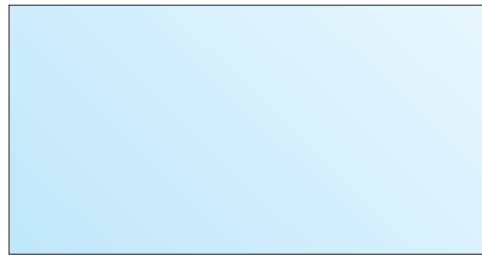

### MAYO COVER

various  
foldings offered

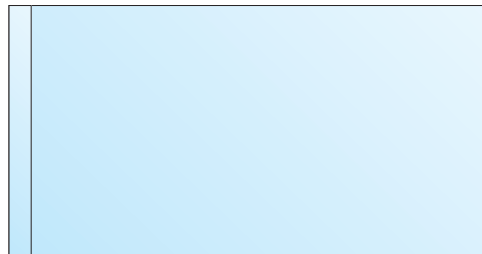

### ARMBOARDS

armboards  
with tape

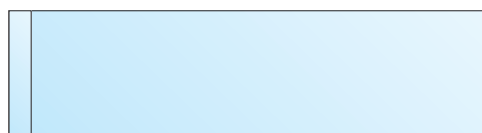

/2

70 x 35 cm

## GOWNS

Made of  
spunlace  
or SMS

M = 130  
L = 140  
XL = 150  
spunlace / SMS



## VARIUS DRAPES

Sizes from 20 x 20 cm until 280 x 160 cm available

Surgical drape  
260 x 160 cm.  
aperture 50 cm  
from top  
incise film and  
closed fluid  
collection bag  
system.

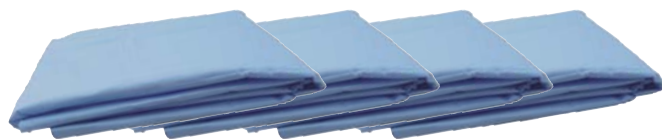

nose bridge  
enforced version  
available





Surgical drape  
260 x 160 cm.  
aperture 50 cm  
from top  
incise film and  
closed fluid  
collection bag  
system.



nose bridge  
enforced version  
available

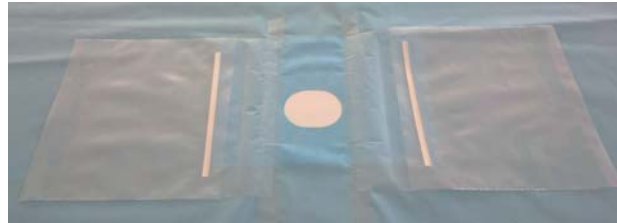

## SPECIAL DRAPES

Surgical Drape  
280 x 160 cm.  
50 cm from top  
1/3 transparent  
2/3 non-woven

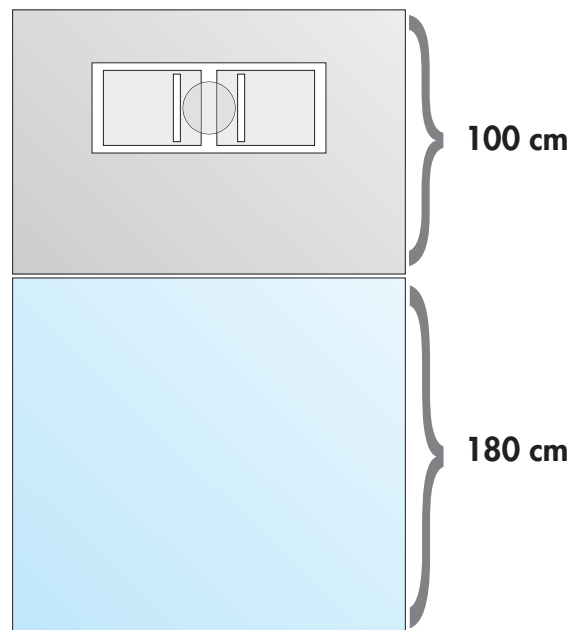

Surgical Drape  
50 x 50 cm.  
Aperature 7,5 cm round  
adhesive tape

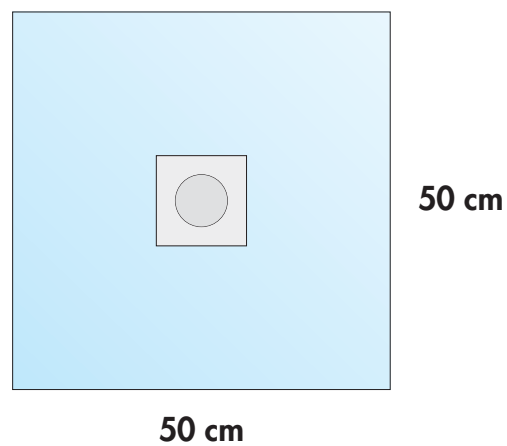

Surgical Drape  
aperture  
adhesive tape

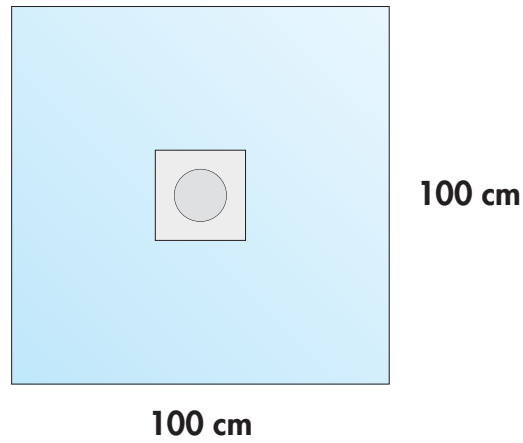

Manufacturer of disposable cannulae, knives and instruments

**STERIMEDIX**  
[www.sterimedix.com](http://www.sterimedix.com)

unique technologies inc

  
**Tecfen**<sup>®</sup>  
MEDICAL  
[www.tecfenmedical.com](http://www.tecfenmedical.com)

**Scilo**  
med-SERVICE  
[www.scilo.de](http://www.scilo.de)

## **We produce packs for Cornea and Tissue Banks!**

**Ref-Nr. 100615**

### **Cardiovascular Tissue Bank**

- 1 crepe paper 60 x 60 cm as wrap
- 2 kidney bowls
- 1 gallipot 250 ml
- 1 pair of anatomic forceps, 4276
- 1 pair of pointed 71360-C scissors
- 1 ruler
- 1 label

**Ref-Nr. 100616**

### **Bavarian Tissue Bank - Bulbus removal**

- 1 crepe paper 60 x 60 cm as wrap
- 1 blue tray
- 1 speculum white 9 cm - AO-123
- 1 fine tipped pair of forceps AO-201
- 1 fine tipped Iris pair of scissors, curved, 11,5 cm, 71360-C
- 1 Jameson strabismus hook 14 cm, AO-720
- 1 fixation pair of forceps Graeffe, 11cm, no lock, AO-210
- 1 enucleation pair of scissors, 1289-C
- 1 label

**Ref-Nr. 100617**

### **Cornea Preparation**

- 1 crepe paper 60 x 60 cm as wrap
- 1 blue tray
- 1 keratin pair of scissors, right, AO-303-R
- 1 keratin pair of scissors, left - AO-303-L
- 1 anatomic pair of forceps Moorfield AO-SA-12
- 1 trephine 15 mm, QTR102L15N
- 1 label

## TREPHINES



### Corneal Punch System & Components

PRODUCT NO.	DESCRIPTION	QTY PER BOX
QTR330010	Corneal Punch System Complete (Includes 7 – 9.0mm Punch Piston, Piston Holder & Base Plate)	1/Box
QTR330005	5-7.0mm Punch Piston	1/Box
QTR330007	7-9.0mm Punch Piston	1/Box
QTR330009	9-11.0mm Punch Piston	1/Box
QTR330001	Disposable Corneal Block (sterile)	1/Box

Tecfen Medical offers a comprehensive selection of corneal trephine blades and tissue punches featuring:

- Long styles
- Compatible with most punch systems
- Consistent results
- Range 4,00 to 18,00 mm diameter
- Eye bank sizes available



### Long Trephines (For Donor or Recipient)



PRODUCT NO.	DESCRIPTION	QTY PER BOX
QTR330250	2.50mm Diameter	1/Box
QTR330300	3.00mm Diameter	1/Box
QTR330350	3.50mm Diameter	1/Box
QTR330400	4.00mm Diameter	1/Box
QTR330450	4.50mm Diameter	1/Box
QTR330500	5.00mm Diameter	1/Box
QTR330550	5.50mm Diameter	1/Box
QTR330575	5.75mm Diameter	1/Box
QTR330600	6.00mm Diameter	1/Box
QTR330625	6.25mm Diameter	1/Box
QTR330650	6.50mm Diameter	1/Box
QTR330675	6.75mm Diameter	1/Box
QTR330700	7.00mm Diameter	1/Box
QTR330725	7.25mm Diameter	1/Box
QTR330750	7.50mm Diameter	1/Box
QTR330775	7.75mm Diameter	1/Box
QTR330785	7.85mm Diameter	1/Box
QTR330800	8.00mm Diameter	1/Box
QTR330825	8.25mm Diameter	1/Box
QTR330850	8.50mm Diameter	1/Box

PRODUCT NO.	DESCRIPTION	QTY PER BOX
QTR330875	8.75mm Diameter	1/Box
QTR330900	9.00mm Diameter	1/Box
QTR330950	9.50mm Diameter	1/Box
QTR331000	10.00mm Diameter	1/Box
QTR331050	10.50mm Diameter	1/Box
QTR331100	11.00mm Diameter	1/Box
QTR331150	11.50mm Diameter	1/Box
QTR331200	12.00mm Diameter	1/Box
QTR331250	12.50mm Diameter	1/Box
QTR331300	13.00mm Diameter	1/Box
QTR331350	13.50mm Diameter	1/Box
QTR331400	14.00mm Diameter	1/Box
QTR331450	14.50mm Diameter	1/Box
QTR331500	15.00mm Diameter	1/Box
QTR331550	15.50mm Diameter	1/Box
QTR331600	16.00mm Diameter	1/Box
QTR331650	16.50mm Diameter	1/Box
QTR331700	17.00mm Diameter	1/Box
QTR331800	18.00mm Diameter	1/Box

## additional components for all different eye surgeries



## Drapes and accessories for Lasik

lasik cannula

M2802 - Buralto 3 port Kanüle / lasik cannula



M2801 - lasik cannula 25g 45°



TE-091D - lasik PVA spear

Q 874 202 - instrument wipe

lasik drain

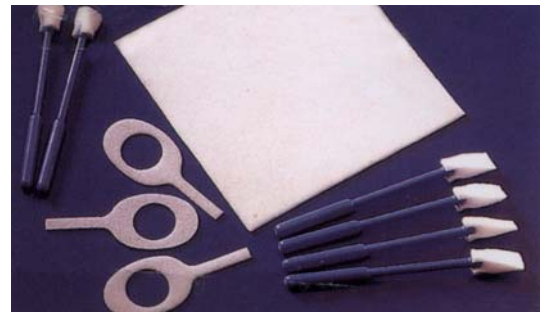

lasik marking pen



# SPECULAE

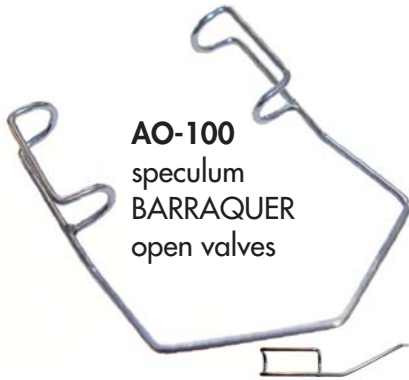

**AO-100**  
speculum  
BARRAQUER  
open valves



**AO-100-GH**  
speculum  
BARRAQUER  
open valves



**AO-101-M**  
speculum  
BARRAQUER  
closed valves

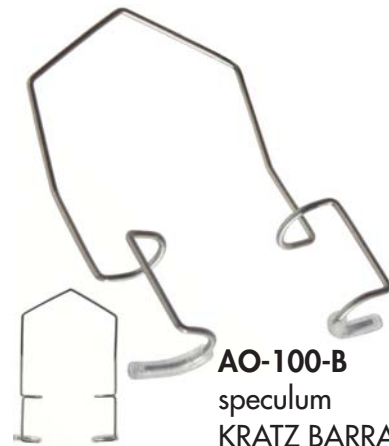

**AO-100-B**  
speculum  
KRATZ BARRAQUER  
open valves



**AO-101**  
speculum  
BARRAQUER  
closed valves



**AO-102-T**  
speculum  
BARRAQUER  
closed valves



**AO-122**  
adjustable speculum  
BANGERTER TEMPORAL



**AO-105**  
adjustable speculum  
CLARK  
open valves

## VARIOUS DISPOSABLE INSTRUMENTS



**M7500**  
3,5/4,0 mm  
Scleral Marker, 80 mm long



**M7510**  
3,5 mm  
Scleral Fixation Plate, 75 mm long



eye-marker standard **AO-400-B**  
flat handle  
3,5 + 4,0 mm, Polyamid



eye-marker medium **AO-404**  
round handle  
3,5 + 4,0 mm, Polyamid



eye-marker small **AO-402**  
round handle  
3,5 + 4,0 mm, Polyamid

## VARIOUS DISPOSABLE INSTRUMENTS

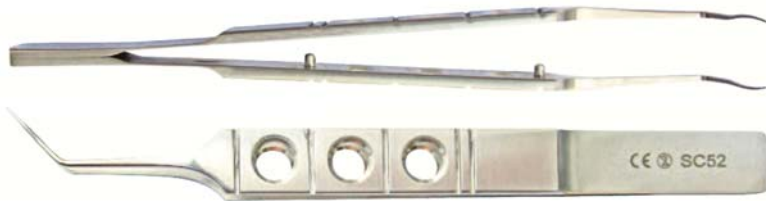

### **AO-252**

micro-forceps, IOL implantation  
45° angled  
length 100 mm



### **AO-190**

forceps Moorfield  
straight, blunt  
length 100 mm



### **AO-209**

micro-forceps with tying platform  
straight, wit 4,5 mm tying platform  
style small  
length 85 mm



### **AO-194**

micro-forceps Capsularhexis  
straight, 45° angled  
tip to angled 14 mm  
style: large  
length 105 mm



### **AO-255**

micro-forceps Hoskins  
0,25 mm notched  
with tying platform  
style small  
length 85 mm



### **AO-200**

micro-forceps Colibri  
1 into 2 teeth (surgical)  
without tying platform  
style small  
length 85 mm



## VARIOUS DISPOSABLE INSTRUMENTS



### AO-202

micro-forceps St. Martin  
1 into 2 teeth (surgical)  
with 5,0 mm tying platform  
length 85 mm



### AO-204

iris-forceps Bonn  
straight, surgical  
length 105 mm

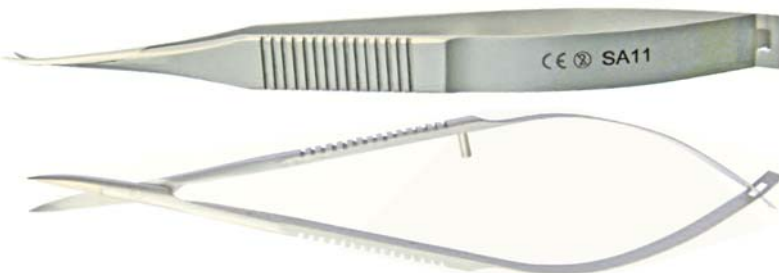

### AO-301-S

micro-scissors (spring-type)  
Westcott  
straight  
scissors for surgical iridectomy  
flat handles  
length 120 mm



### AO-865

needle holder Castroviejo  
curved  
with lock, 6 mm delicate jaw flat  
riffle handles  
length 120 mm



### 71360

iris-scissors  
fine  
different variation  
length 115 mm

## Disposable surgical packs

date: \_\_\_\_\_

**OFFER**

**Address:**

**SAMPLE, quantity:** \_\_\_\_\_

**Company:** \_\_\_\_\_

**surgeries p.a.:** \_\_\_\_\_

**contact person:**  
 \_\_\_\_\_

**street:** \_\_\_\_\_

**city, zip code, country:** \_\_\_\_\_

**surgery: cataract/vitrectomy/retinal/others:** \_\_\_\_\_

**drape**

**size:**

**aperture:**

4 x 7 cm

6 x 8 cm

**fenestration:**

10 x 10 cm

7,5 cm

11,5 x 12,5 cm

**adhesive around aperture:**

yes

no

**incies film:**

normal

Tegaderm

**integrated:**

yes

no

**fluid collection bag:**

integrated

separate

no

**bridge:**

yes

no

**instrument table drape:**

size 75 x 90 cm

size 140 x 150 cm

**as wrap:**

yes

no

**phaco table drape:**

**size:** \_\_\_\_\_

Tape yes

Tape no

**Mayo cover:**

size 90 x 60 cm

size 145 x 80 cm

**disposable gowns:**  
 (paper towel included)

size M quantity: \_\_\_\_\_  size L quantity: \_\_\_\_\_

size XL quantity: \_\_\_\_\_

**armboards 75 x 35 cm**

with Tape

without Tape

**gloves – always separately delivered:**

**name:** \_\_\_\_\_

**size:** \_\_\_\_\_ **quantity:** \_\_\_\_\_

**size:** \_\_\_\_\_ **quantity:** \_\_\_\_\_

**examination gloves Ethiparat:**

yes

no

**miscellaneous:** \_\_\_\_\_



## additional components

Date: \_\_\_\_\_

**sample, quantity** \_\_\_\_\_

**syringes:**

included

separate

1 ml Luer, quantity: \_\_\_\_\_

LuerLock

2 ml Luer, quantity: \_\_\_\_\_

LuerLock

5 ml Luer, quantity: \_\_\_\_\_

LuerLock

10 ml Luer, quantity: \_\_\_\_\_

LuerLock

20 ml Luer, quantity: \_\_\_\_\_

LuerLock

**cannulae:**

size: \_\_\_\_\_ quantity: \_\_\_\_\_

size: \_\_\_\_\_ quantity: \_\_\_\_\_

size: \_\_\_\_\_ quantity: \_\_\_\_\_

**eye-pad:**

closed

quantity: \_\_\_\_\_

**pro-ophta-sticks:**

quantity: \_\_\_\_\_

**eye spears:**

quantity: \_\_\_\_\_

**swabs:**

size 2

size 3

size 4

size 6

quantity: \_\_\_\_\_

**cotton swabs:**

plastic

wood

quantity: \_\_\_\_\_

**gauze swabs:**

5 x 5 cm quantity: \_\_\_\_\_

7,5 x 7,5 cm quantity: \_\_\_\_\_

10 x 10 cm quantity: \_\_\_\_\_

**surgical drain:**

**eye shield:**

white

transparent

**gallipots:**

60 ml

120 ml

250 ml

quantity: \_\_\_\_\_

**kidney bowl:**

**instrument-wipe**

**plastic forceps**

**filter:**

water

air

**single fluid administration set**

**scalpel:**

size: \_\_\_\_\_

**Steri strips:**

quantity: \_\_\_\_\_

**disposable knives:**

phaco knife  2,5

2,8

3,0

crescent knife

15° knife

straight

angled

MVR knife

19 g

20 g

implant knife

other \_\_\_\_\_

**miscellaneous:** \_\_\_\_\_



# **NORDSET**

GmbH & Co. KG

P.O. Box 12 13 · 27795 Hude  
Zur Burg 4 · 27798 Hude  
Germany

Phone +49 44 08 / 80 700 - 0  
Fax: +49 44 08 / 80 700 10

**E-Mail: [k.scholz@nordset.de](mailto:k.scholz@nordset.de)**  
**[www.nordset.de](http://www.nordset.de)**